

LINHA DE PRODUTOS 2024

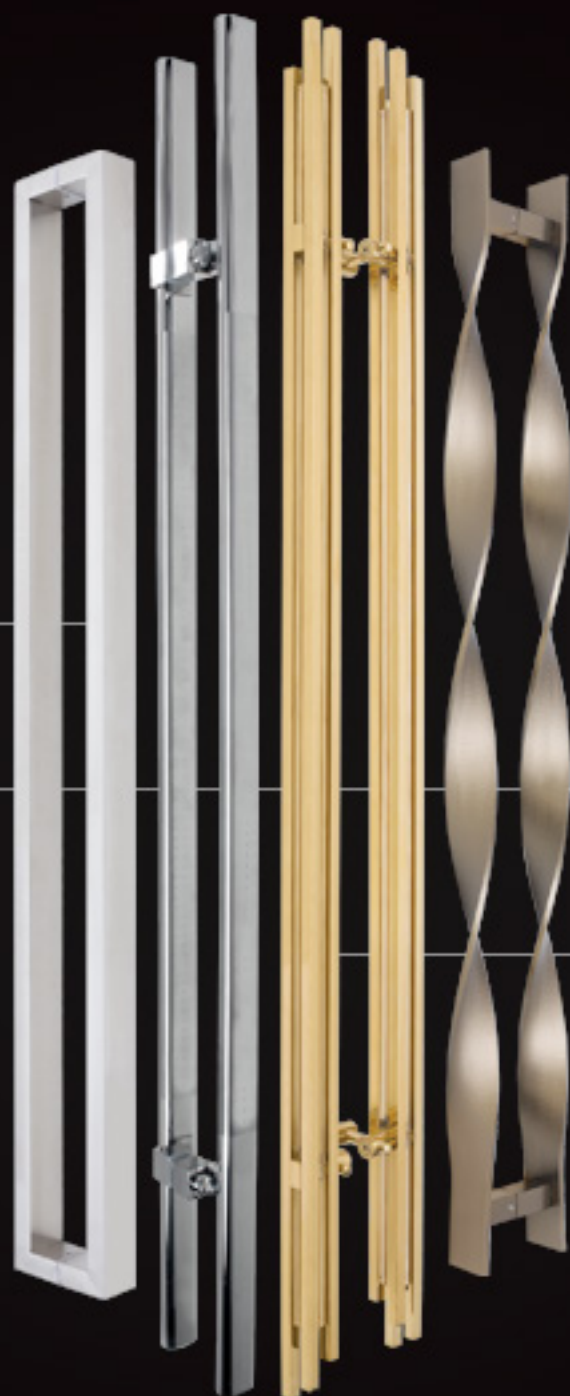

Nossa História

Iniciamos nossas atividades em 1994, como importadora de puxadores e ferragens, com sede própria no bairro de Moema em São Paulo.

Nossas importações e distribuições de puxadores e ferragens, atende revendedores ferragistas, home centers, materiais de construção, madeireiras e outros.

Trabalhamos com os melhores fabricantes de diversos países, e nesses anos de atividade visitamos cada um, sem exceção. Neles realizamos o acompanhamento de produtos em todos os níveis de qualidade, em diversos estágios de fabricação.

Possibilitando assim, garantia a todos os nossos produtos por 1 ano, contra qualquer defeito de qualidade e/ou fabricação (salvo casos de uso indevido ou má colocação).

Além disso, oferecemos vários itens de nossa própria fabricação com a mesma garantia.

01

Alças para Portas
de Madeira e Vidro

Pág. 05 a 24



02

Fechos

Pág.26

03

Dobradiças

Pág.28 a 44

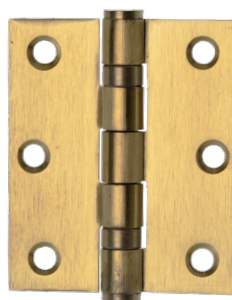

04

Puxadores

Pág.46 a 48

CODIFICAÇÃO DE ACABAMENTOS

AE - Aço INOX Escovado

AIP - Aço INOX Polido

DOU-ESC - Dourado Escovado

FPRE - Ferro Preto fosco

ANT - Alumínio Escovado Antique

BRA - Branco

CRO - Cromado

DOU - Dourado Brilhante

FN - Ferro Niquelado

NF - Niquel Fosco

PRE - Preto Fosco

01

Alças para Portas de Madeira e Vidro

Pág. 05 a 24



50059

ALUMÍNIO

Acab.:ANT

25 x 288 x 378 mm
25 x 544 x 634 mm
25 x 800 x 890 mm



50088

ALUMÍNIO

50 x 6 x 600 x 710 mm
50 x 6 x 1000 x 1110 mm
acbto. ANT



50059

ALUMÍNIO

Acab.:PRE

25 x 300 x 390 mm
25 x 500 x 590 mm
25 x 800 x 890 mm



50088

ALUMÍNIO

50 x 6 x 600 x 710 mm
50 x 6 x 1000 x 1110 mm
acbto. PRE

MA 179 AE/AIP

INOX 304

25 x 275 x 300 mm



SPH 057 AE

INOX 304

32 x 468 x 500 mm





MA 180 AE/ AIP

INOX 304

25 x 474 x 500 mm

SPH 060 AE

INOX 304



32 x 555 x 600 mm



JY 301 AE

INOX 304

32 x 612 x 650 mm



DH 8020
AE/ AIP

INOX 304

45 x 25 x 600 x 800 mm

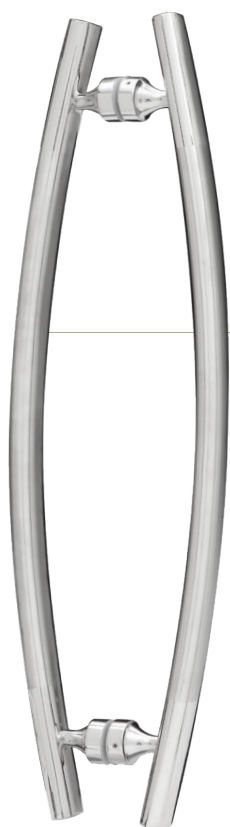

DH 8030
AE/AIP

INOX 304

45 x 25 x 650 x 800 mm



DH 2275
AE/ AIP

INOX 304

38 x 450 x 800 mm

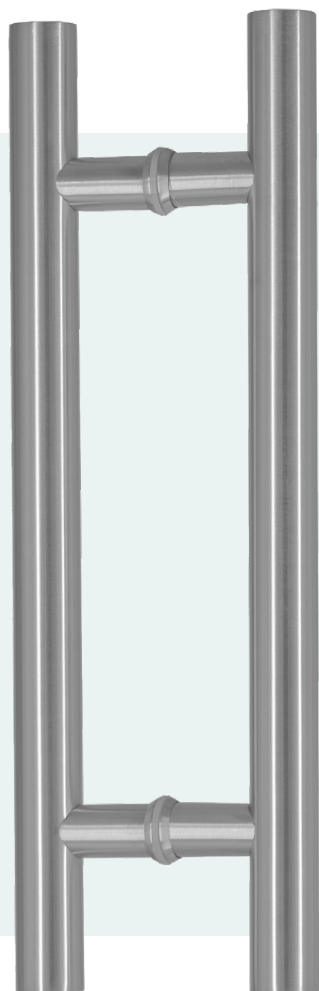

DH 1003

INOX 304

Acab.: AIP

32 x 300 x 450 mm
32 x 400 x 600 mm
32 x 700 x 1000 mm

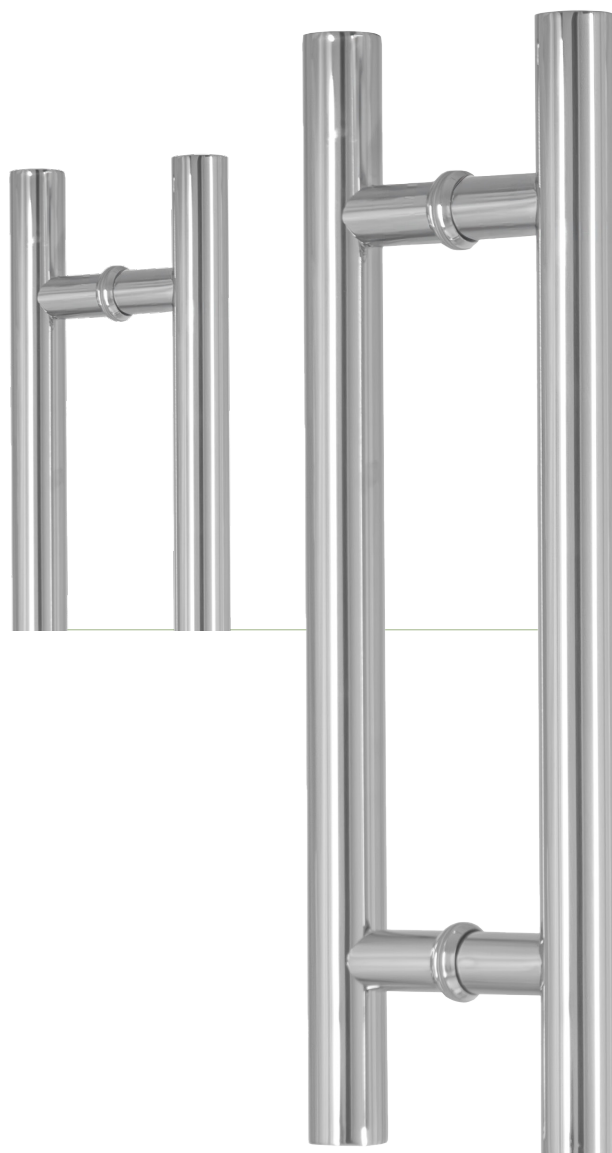

DH 1003

INOX 304

Acab.: AE

32 x 300 x 450 mm
32 x 400 x 600 mm
32 x 700 x 1000 mm

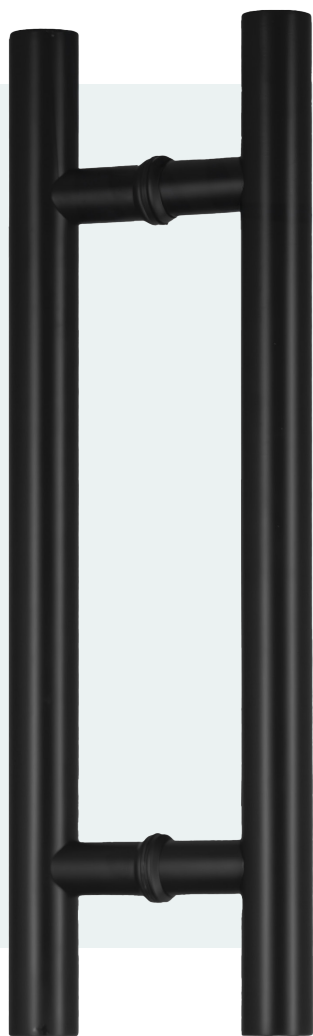

DH 1003

INOX 304

Acab.: DOU

32 x 300 x 450 mm
32 x 400 x 600 mm
32 x 700 x 1000 mm



DH 1003

INOX 304

Acab.: PRE

32 x 300 x 450 mm
32 x 400 x 600 mm
32 x 700 x 1000 mm

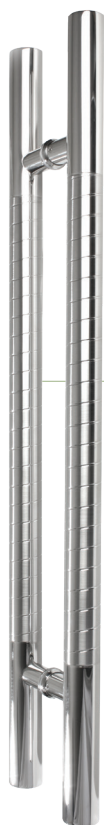

LY 232 AIP

INOX 304

38 x 550 x 800 mm



HD 257 DOU

INOX 304

19 x 38 x 400 x 600 mm
19 x 38 x 700 x 1000 mm
25 x 45 x 800 x 1200 mm

DH 210 AE/ AIP

INOX 304

25 x 45 x 600 x 800 mm





JY 226 AE

INOX 304

38 x 20 x 800 x 1200 mm



JY 349A AIP
CRISTAL

INOX 304

15 x 15 x 1000 x 1500 mm

JY 349A DOU

INOX 304

15 x 15 x 1000 x 1500 mm



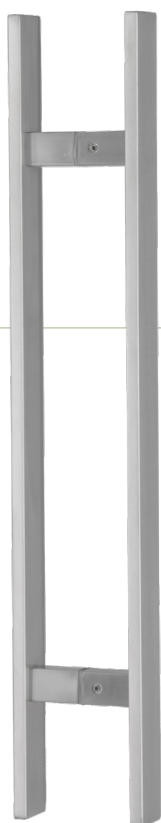

DH 1611

INOX 304

Acab.: AE

40 x 10 x 300 x 400 mm
40 x 100 x 400 x 600 mm
40 x 10 x 800 x 1000 mm
40 x 10 x 1000 x 1200mm



DH 1611

INOX 304

Acab.: DOU

40 x 10 x 300 x 400 mm
40 x 100 x 400 x 600 mm
40 x 10 x 800 x 1000 mm
40 x 10 x 1000 x 1200mm

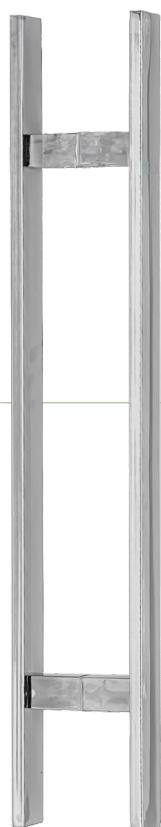

DH 1611

INOX 304

Acab.: AIP

40 x 10 x 300 x 400 mm
40 x 100 x 400 x 600 mm
40 x 10 x 800 x 1000 mm
40 x 10 x 1000 x 1200mm

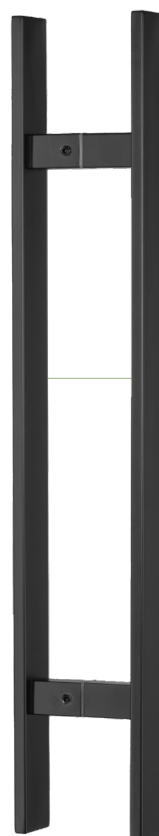

DH 1611

INOX 304

Acab.: PRE

40 x 10 x 300 x 400 mm
40 x 100 x 400 x 600 mm
40 x 10 x 800 x 1000 mm
40 x 10 x 1000 x 1200mm

DH 1611

INOX 304

Acab.: DOU

30x10x200x300mm



DH 1611

INOX 304

Acab.: AE

30x10x200x300mm

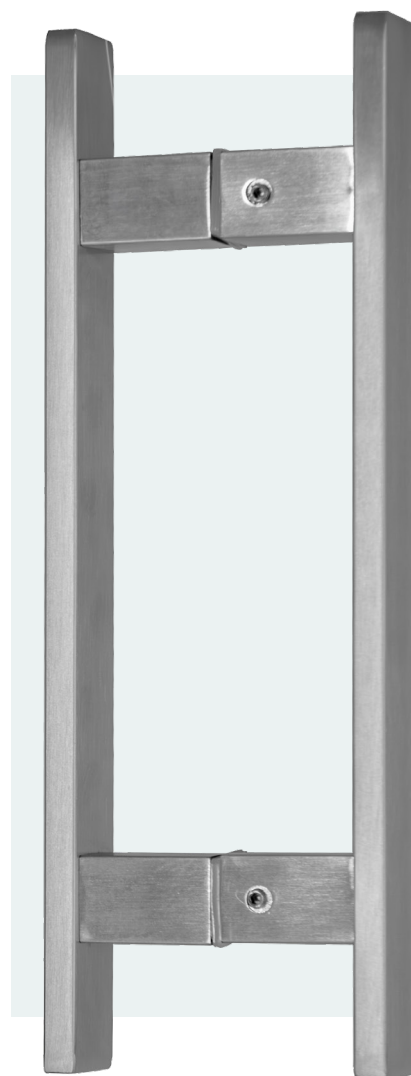



DH 1611

INOX 304

Acab.: AIP

30x10x200x300mm

DH 1611

INOX 304

Acab.: PRE

30x10x200x300mm



JY 578A

ALUMÍNIO/ MADEIRA



51x 1250 x 1500 mm



DH 1157

INOX 304

Acab.: DOU

30 x 15 x 300 x 315 mm
30 x 15 x 400 x 415 mm
30 x 15 x 600 x 615 mm
30 x 15 x 800 x 815 mm
50 x 25 x 975 x 1000 mm
50 x 25 x 1175 x 1200 mm
50 x 25 x 1775 x 1800 mm



DH 1157

INOX 304

Acab.: PRE

30 x 15 x 300 x 315 mm
30 x 15 x 400 x 415 mm
30 x 15 x 600 x 615 mm
30 x 15 x 800 x 815 mm
50 x 25 x 975 x 1000 mm
50 x 25 x 1175 x 1200 mm
50 x 25 x 1775 x 1800 mm



DH 1157

INOX 304

Acab.: AIP

30 x 15 x 300 x 315 mm
30 x 15 x 400 x 415 mm
30 x 15 x 600 x 615 mm
30 x 15 x 800 x 815 mm
50 x 25 x 975 x 1000 mm
50 x 25 x 1175 x 1200 mm
50 x 25 x 1775 x 1800 mm

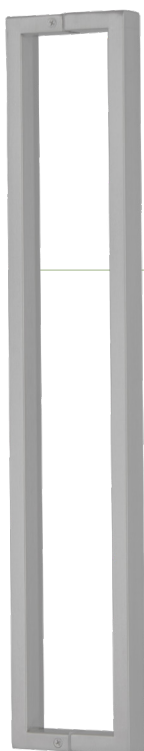

DH 1157

INOX 304

Acab.: AE

30 x 15 x 300 x 315 mm
30 x 15 x 400 x 415 mm
30 x 15 x 600 x 615 mm
30 x 15 x 800 x 815 mm
50 x 25 x 975 x 1000 mm
50 x 25 x 1175 x 1200 mm
50 x 25 x 1775 x 1800 mm

DH 1157

INOX 304

Acab.: COE

50 x 25 x 1175 x 1200 mm
50 x 25 x 1775 x 1800 mm





DH 1136

AÇO INOX 304

Acabtos.: BRA

25 x 300 x 325 mm



DH 1136

AÇO INOX 304

Acabtos.: AE

25 x 300 x 325 mm

DH 1136

AÇO INOX 304

Acabtos.: PRE

25 x 300 x 325 mm



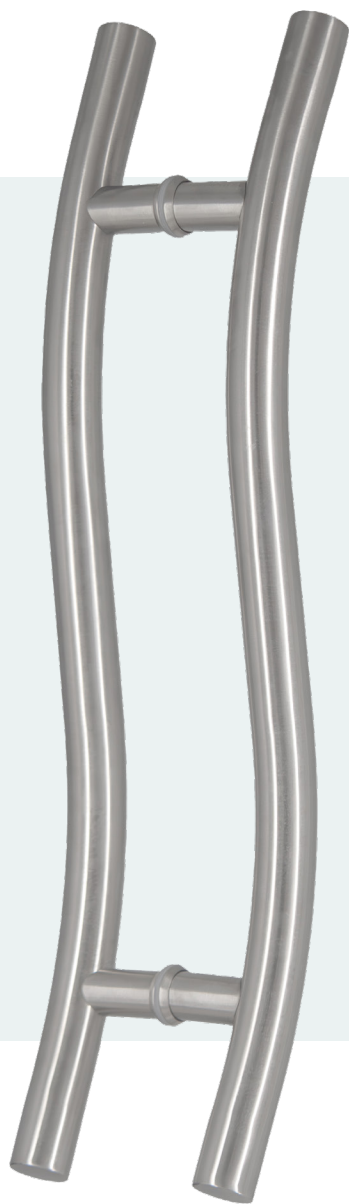

DH 1236

AÇO INOX 304

Acabtos.: AE

32 x 400 x 600 mm

DH 1236

AÇO INOX 304

Acabtos.: PRE

32 x 400 x 600 mm





DH 1228

AÇO INOX 304

Acabtos.: BRA

32 x 300 x 325 mm



DH 1228

AÇO INOX 304

Acabtos.: AE

35 x 300 x 325 mm

DH 1228

AÇO INOX 304

Acabtos.: PRE

35 x 300 x 325 mm





DH 1002

AÇO INOX 304

Acabtos.: AIP

25 x 200 x 300 mm



DH 1002

AÇO INOX 304

Acabtos.: PRE

25 x 200 x 300 mm



DH 1002

AÇO INOX 304

Acabtos.: AE

25 x 200 x 300 mm



DH 1002

AÇO INOX 304

Acab.: DOU

25 x 200 x 300 mm

DH1612

INOX 304

Acabtos.: AE

40 x 10 x 300 x 400 mm
40 x 10 x 400 x 600 mm
40 x 10 x 800 x 1000 mm
40 x 10 x 1000 x 1200 mm



DH 1612

INOX 304

Acabtos.: AIP

40 x 10 x 300 x 400 mm
40 x 10 x 400 x 600 mm
40 x 10 x 800 x 1000 mm
40 x 10 x 1000 x 1200 mm





DH 1612

INOX 304

Acabtos.: PRE

40 x 10 x 400 x 600 mm
40 x 10 x 1000 x 1200 mm

DH 1612

INOX 304

Acabtos.: COE

40 x 10 x 400 x 600 mm
40 x 10 x 1000 x 1200 mm



DH 1612

INOX 304

Acabtos.: DOU

40 x 10 x 400 x 600 mm
40 x 10 x 1000 x 1200 mm



50091
INOX 304

Acabtos.: AE

Regulável entre furos
25 x (100 até 400mm) x 500 mm
25 x (100 até 900mm) x 1000 mm

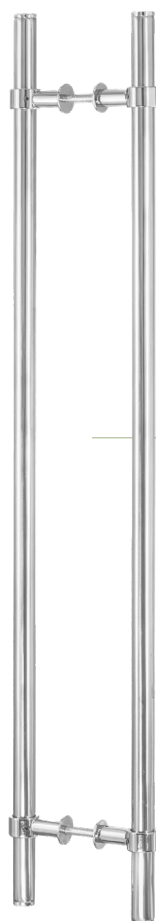

50091
INOX 304

Acabtos.: AIP

Regulável entre furos
25 x (100 até 400mm) x 500 mm
25 x (100 até 900mm) x 1000 mm

50091

INOX 304

Acabtos.: PRE

Regulável entre furos
25 x (100 até 400mm) x 500 mm
25 x (100 até 900mm) x 1000 mm

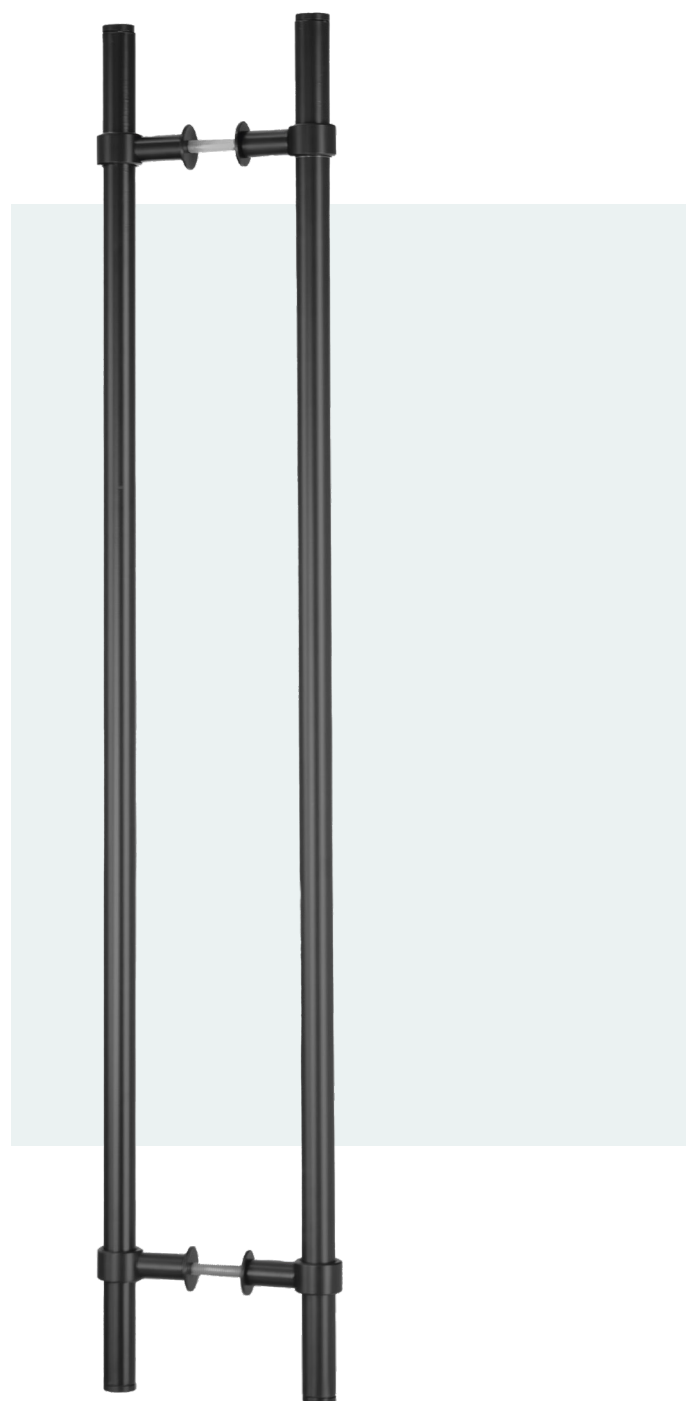

02

Fechos

Pág. 26

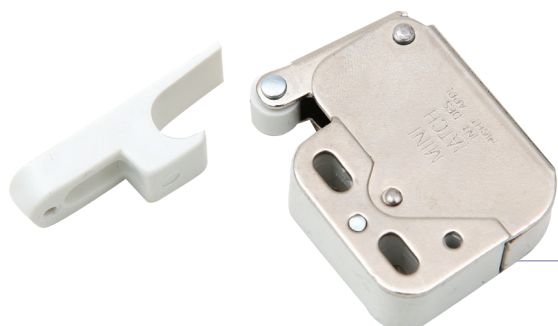

FECHO TOC

6119 FN



FECHO TOC MAGNÉTICO

8909 PLÁSTICO



FECHO TOC

6210 FZ

03

Dobradiças

Pág. 28 a 44

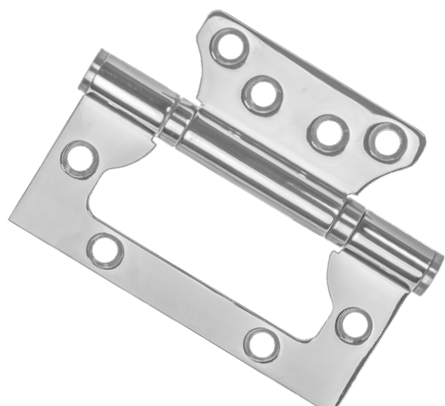

55039

DOBRADIÇA COM ROLAMENTOS

4 x 3"
Aço INOX 201
Sobrepor - Dispensa o rebaixo
(Cava) na porta e no batente
Acabto.: AIP
Capacidade 25 kgs (3 pçs.)



55039

DOBRADIÇA COM ROLAMENTOS

4 x 3"
Aço INOX 201
Sobrepor - Dispensa o rebaixo
(Cava) na porta e no batente
Acabto.: PRE
Capacidade 25 kgs (3 pçs.)



55039

DOBRADIÇA COM ROLAMENTOS

4 x 3"
Aço INOX 201
Sobrepor - Dispensa o rebaixo
(Cava) na porta e no batente
Acabto.: AE
Capacidade 25 kgs (3 pçs.)

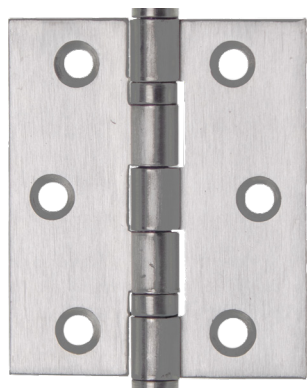

55038

DOBRADIÇA COM ROLAMENTOS

3 x 2 ½
76 x 63 x 2 mm
Capacidade 30 kgs (3 pçs.)
Aço INOX 201
Acabto.: AE



55038

DOBRADIÇA COM ROLAMENTOS

3 x 2 ½
76 x 63 x 2 mm
Capacidade 30 kgs (3 pçs.)
Aço INOX 201
Acabto.: AIP

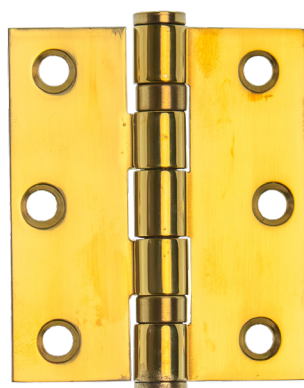

55038

DOBRADIÇA COM ROLAMENTOS

3 x 2 ½
76 x 63 x 2 mm
Capacidade 30 kgs (3 pçs.)
Aço INOX 201
Acabto.: DOU



55038

DOBRADIÇA COM ROLAMENTOS

3 x 2 ½
76 x 63 x 2 mm
Capacidade 30 kgs (3 pçs.)
Aço INOX 201
Acabto.: PRE

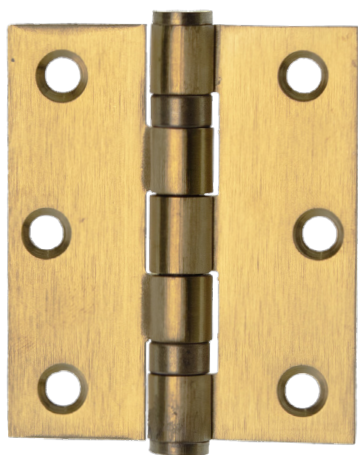

55038

DOBRADIÇA COM ROLAMENTOS

3 x 2 ½
76 x 63 x 2 mm
Capacidade 30 kgs (3 pçs.)
Aço INOX 201
Acabto.: DOU_ESC



55038

DOBRADIÇA COM ROLAMENTOS

3 ½ x 3
89 x 76 x 2,5 mm
Capacidade 35 kgs (3 pçs.)
Aço INOX 201
Acabto.: AE



55038

DOBRADIÇA COM ROLAMENTOS

3 ½ x 3
89 x 76 x 2,5 mm
Capacidade 35 kgs (3 pçs.)
Aço INOX 201
Acabto.: AIP



55038

DOBRADIÇA COM ROLAMENTOS

3 ½ x 3
89 x 76 x 2,5 mm
Capacidade 35 kgs (3 pçs.)
Aço INOX 201
Acabto.: DOU



55038

DOBRADIÇA COM ROLAMENTOS

3 ½ x 3
89 x 76 x 2,5 mm
Capacidade 35 kgs (3 pçs.)
Aço INOX 201
Acabto.: PRE



55038

DOBRADIÇA COM ROLAMENTOS

3 ½ x 3
89 x 76 x 2,5 mm
Capacidade 35 kgs (3 pçs.)
Aço INOX 201
Acabto.: DOU ESC

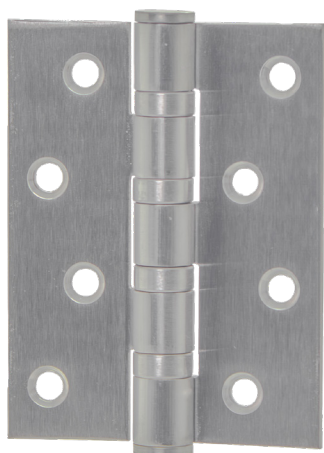

55038

DOBRADIÇA COM ROLAMENTOS

4 x 3
101 x 76 x 3 mm
Capacidade 40 kgs (3 pçs.)
Aço INOX 201
Acabto.: AE



55038

DOBRADIÇA COM ROLAMENTOS

4 x 3
101 x 76 x 3 mm
Capacidade 40 kgs (3 pçs.)
Aço INOX 201
Acabto.: AIP

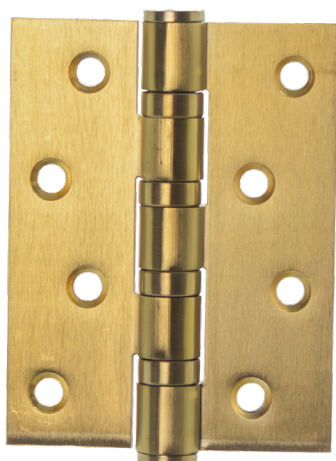

55038

DOBRADIÇA COM ROLAMENTOS

4 x 3
101 x 76 x 3 mm
Capacidade 40 kgs (3 pçs.)
Aço INOX 201
Acabto.: DOU-ESC



55038

DOBRADIÇA COM ROLAMENTOS

4 x 3
101 x 76 x 3 mm
Capacidade 40 kgs (3 pçs.)
Aço INOX 201
Acabto.: PRE



55038

DOBRADIÇA COM ROLAMENTOS

4 x 3
101 x 76 x 3 mm
Capacidade 40 kgs (3 pçs.)
Aço INOX 201
Acabto.: DOU

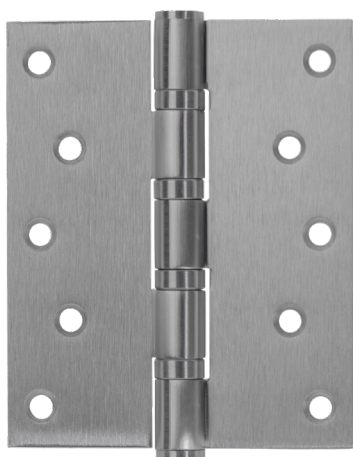

55038

DOBRADIÇA COM ROLAMENTOS

5 x 4
127 x 101 x 3 mm
Capacidade 60 kgs (3 pçs.)
Aço INOX 201
Acabto.: AE

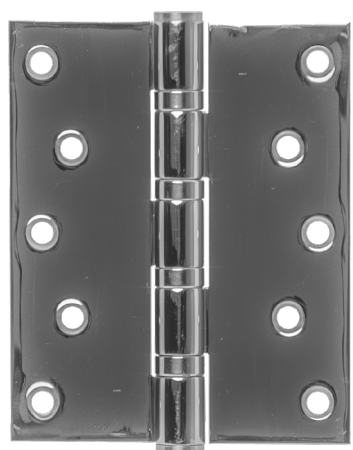

55038

DOBRADIÇA COM ROLAMENTOS

5 x 4
127 x 101 x 3 mm
Capacidade 60 kgs (3 pçs.)
Aço INOX 201
Acabto.: AIP

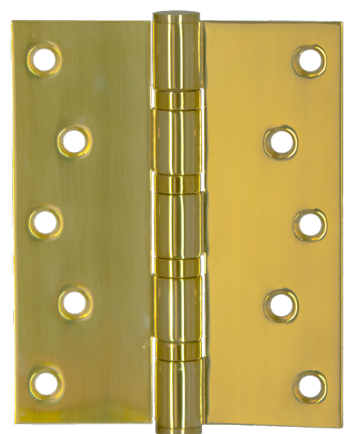

55038

DOBRADIÇA COM ROLAMENTOS

5 x 4
127 x 101 x 3 mm
Capacidade 60 kgs (3 pçs.)
Aço INOX 201
Acabto.: DOU



55038

DOBRADIÇA COM ROLAMENTOS

5 x 4
127 x 101 x 3 mm
Capacidade 60 kgs (3 pçs.)
Aço INOX 201
Acabto.: PRE

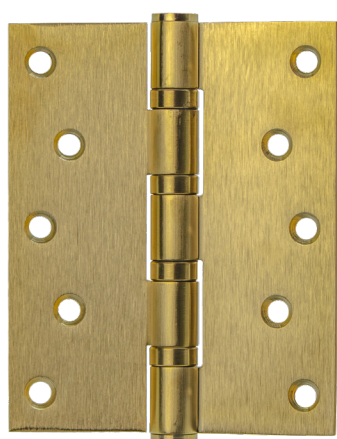

55038

DOBRADIÇA COM ROLAMENTOS

5 x 4
127 x 101 x 3 mm
Capacidade 60 kgs (3 pçs.)
Aço INOX 201
Acabto.: DOU-ESC



55038

BLISTER

3 ½ x 3 x 2,5mm
4 x 3 x 3mm
AE e AIP
Dobradiças em Aço INOX 201
Com rolamentos

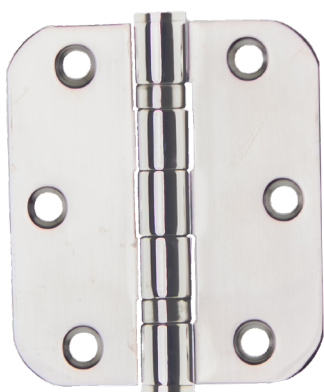

55038

DOBADIÇA COM ROLAMENTOS

3 ½ x 3 x 2,5mm
Aço INOX 201
Canto redondo
Acabto.: AIP
Capacidade 35 kgs (3 pçs.)

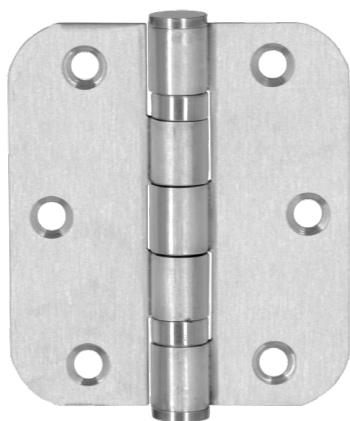

55038

DOBADIÇA COM ROLAMENTOS

3 ½ x 3 x 2,5mm
Aço INOX 201
Canto redondo
Acabto.: AE
Capacidade 35 kgs (3 pçs.)



55038

DOBRADIÇA COM PINO DE SEGURANÇA

4 x 3"x3 mm
101x76x3 mm
Aço INOX 201
com rolamentos
Acabto.: AE
Capacidade 40 kgs (3 pçs.)



55038

DOBRADIÇA COM PINO DE SEGURANÇA

4 x 3"x3 mm
101x76x3 mm
Aço INOX 201
com rolamentos
Acabto.: AIP
Capacidade 40 kgs (3 pçs.)



55038

DOBRADIÇA COM PINO DE SEGURANÇA

4 x 3"x3 mm
101x76x3 mm
Aço INOX 201
com rolamentos
Acabto.: PRE
Capacidade 40 kgs (3 pçs.)



55038

DOBRADIÇA COM PINO DE SEGURANÇA

4 x 3"x3 mm
101x76x3 mm
Aço INOX 201
com rolamentos
Acabto.: DOU-ESC
Capacidade 40 kgs (3 pçs.)



55042

DOBRADIÇA COM MOLA

3 ½ x 3x3 mm
89x76x3 mm
Aço INOX 201
Acabto.: AE
Capacidade 35 kgs (3 pçs.)



55042

DOBRADIÇA COM MOLA

3 ½ x 3x3 mm
89x76x3 mm
Aço INOX 201
Acabto.: PRE
Capacidade 35 kgs (3 pçs.)

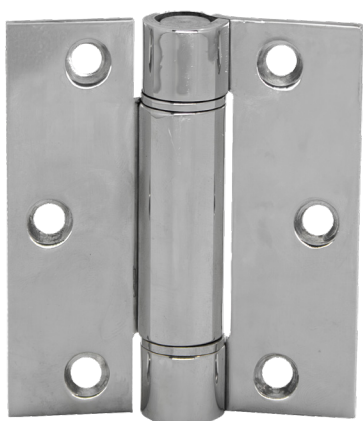

55042

DOBRADIÇA COM MOLA

3 ½ x 3x3 mm
89x76x3 mm
Aço INOX 201
Acabto.: AIP
Capacidade 35 kgs (3 pçs.)

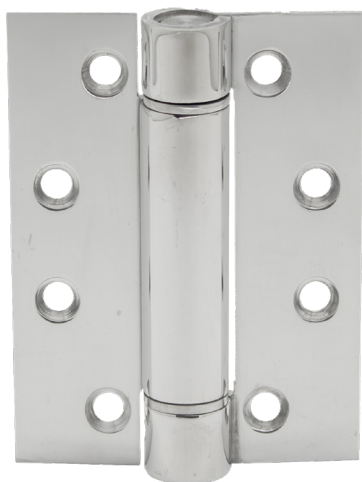

55042

DOBRADIÇA COM MOLA

4 x 3x3 mm
101x76x3 mm
Aço INOX 201
Acabto.: AIP
Capacidade 40 kgs (3 pçs.)

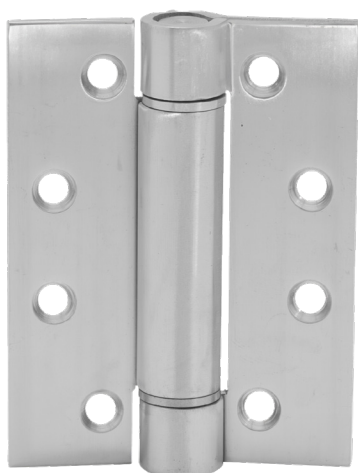

55042

DOBRADIÇA COM MOLA

4 x 3x3 mm
101x76x3 mm
Aço INOX 201
Acabto.: AE
Capacidade 40 kgs (3 pçs.)



55042

DOBRADIÇA COM MOLA

4 x 3x3 mm
101x76x3 mm
Aço INOX 201
Acabto.: PRE
Capacidade 40 kgs (3 pçs.)

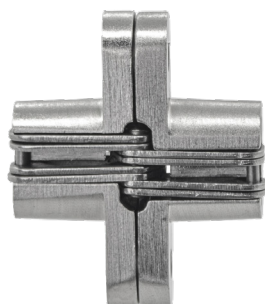

55041

DOBRADIÇA INVISÍVEL

45 x 13 x 9 mm
Corpo em Zamack NF
Mecanismo em Aço INOX
45 mm
capacidade 15 kgs (3 pçs.)

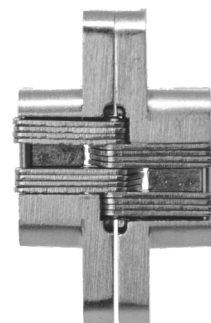

55041

DOBRADIÇA INVISÍVEL

60 x 13 x 9 mm
Corpo em Zamack NF
Mecanismo em Aço INOX
60 mm
capacidade 30 kgs (3 pçs.)

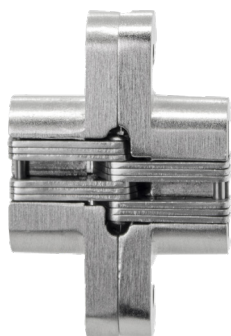

55041

DOBRADIÇA INVISÍVEL

70 x 16 x 11 mm
Corpo em Zamack NF
Mecanismo em Aço INOX
70 mm
capacidade 45 kgs (3 pçs.)



55041

DOBRADIÇA INVISÍVEL

95 x 10 x 13 mm
Corpo em Zamack NF
Mecanismo em Aço INOX
90 mm
capacidade 75 kgs (3 pçs.)

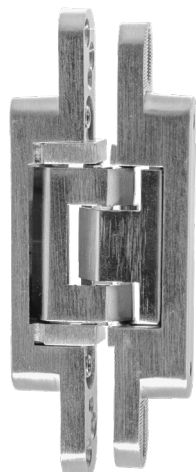

HG007

DOBRADIÇA INVISÍVEL 3D

140 x 135 x 18 x 21 mm

Zamack NF

Capacidade 20 kgs – 1 pç

Espessura mínima da porta 30 mm



HG007

DOBRADIÇA INVISÍVEL 3D

140 x 135 x 18 x 21 mm

Zamack NF

Capacidade 20 kgs – 1 pç

Espessura mínima da porta 30 mm

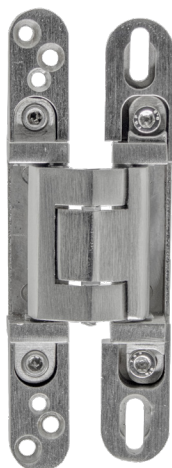

HG007

DOBRADIÇA INVISÍVEL 3D

140 x 135 x 18 x 21 mm

Zamack NF

Capacidade 20 kgs – 1 pç

Espessura mínima da porta 30 mm

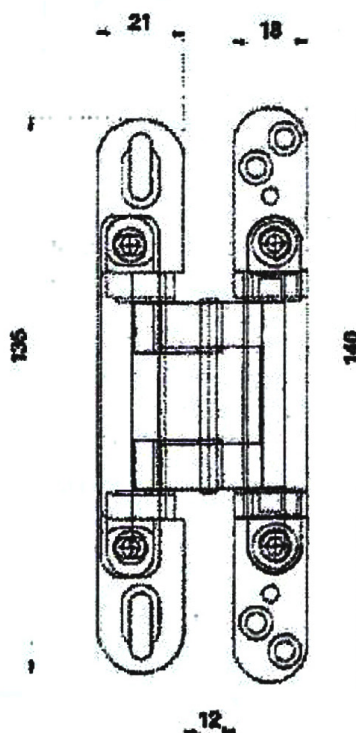



HG013

DOBRADIÇA INVISÍVEL 3D

160 x 138 x 29 mm
Zamack NF
Capacidade 30 kgs – 1 pç
Espessura mínima da porta 40 mm

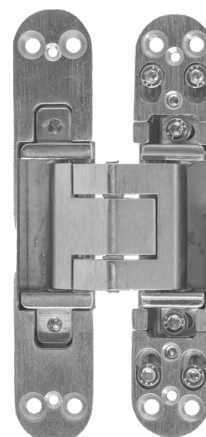

HG013

DOBRADIÇA INVISÍVEL 3D

160 x 138 x 29 mm
Zamack NF
Capacidade 30 kgs – 1 pç
Espessura mínima da porta 40 mm

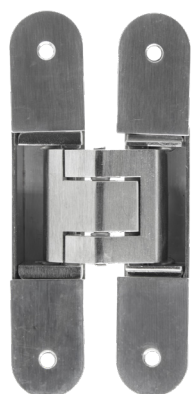

HG013

DOBRADIÇA INVISÍVEL 3D

160 x 138 x 29 mm
Zamack NF
Capacidade 30 kgs – 1 pç
Espessura mínima da porta 40 mm

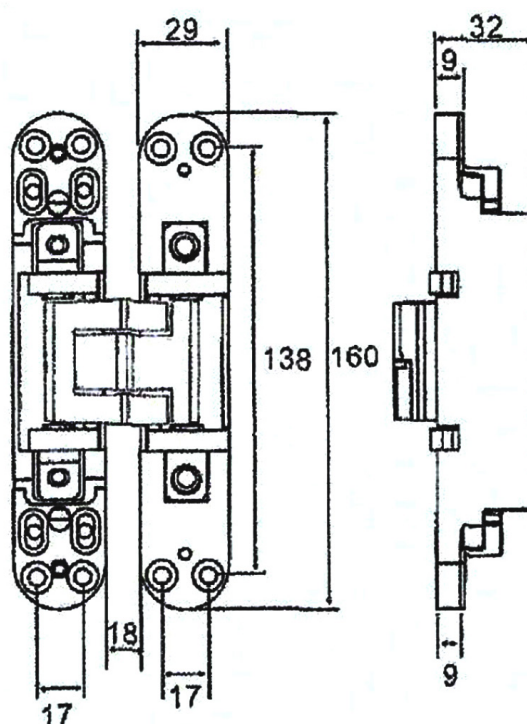

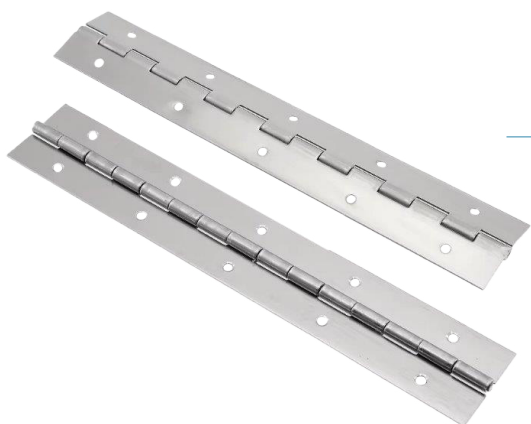

DOBRADIÇA PIANO

VARA

Aço INOX 201
25 x 0,6 x 2400 mm
30 x 0,6 x 2400 mm



5831

FECHADURA TUBULAR

70 mm
Aço INOX 202
Para portas de divisórias
ou convencionais



PRENDEDOR

2015

28 x 18 x 43 x 77 mm
aço inox 304
acbto. AE

03

Puxadores

Pág. 46 a 48



20001

25/ 32 / 38 mm
PORCELANA
BRA



22000

25/ 32 mm
PORCELANA



20006

38/ 44 mm
PORCELANA
BRA



21011 F24

32/ 38 mm
PORCELANA



21000
F97

32/ 38 mm
PORCELANA



22900
W/B

32/ 38 mm
PORCELANA



21900
F119

32/ 38 mm
PORCELANA



21013
F05

32/ 38 mm
PORCELANA



21000
F66

32/ 38 mm
PORCELANA



21900
F65

32/ 38 mm
Porcelana



20001
PRE

32/ 38 mm
Porcelana



26063

Resina
38 mm



26064

Resina
38 mm



26065

Resina
38 mm



26066

Resina
38 mmv



(11) 5051-0639 (11) 99935-6866
billbskf@terra.com.br
bskf.com.br